

USER MANUAL
neodrives Z20
FROM MODEL YEAR 2018 ONWARDS

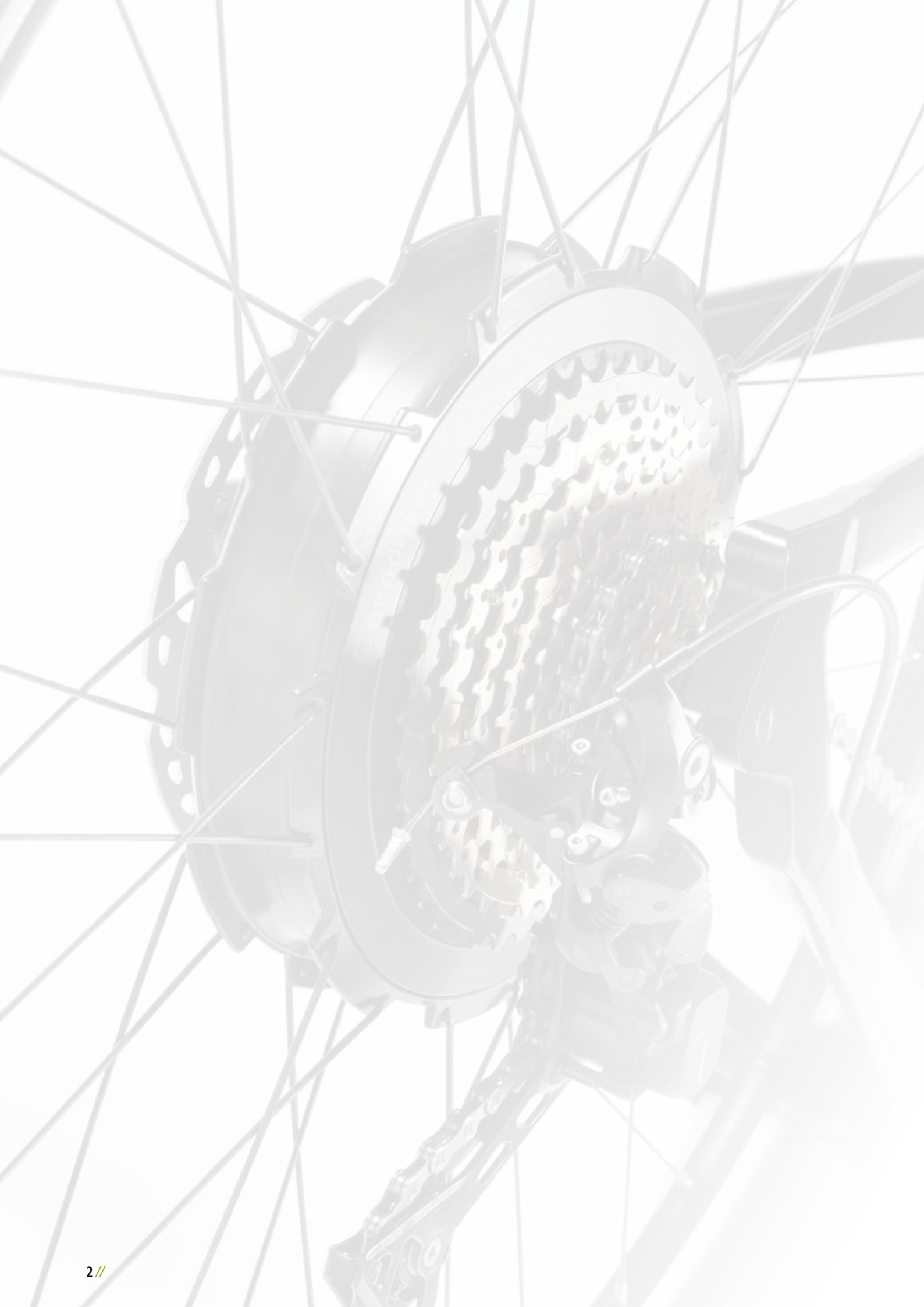

100 % riding fun guaranteed

Dear Customer,

This user manual provides a comprehensive overview of the use of the neodrives rear-mounted motor system Z20.

When developing the new Z20 generation we focused on maximum riding performance – no other system should give a smoother, more agile ride than the neodrives rear motor.

So just pedal away and enjoy your ride to the max!

We wish you a great ride with the neodrives rear motor.

Contents

1	Introduction	
	Why the neodrives rear motor?	6
1.1	Our pledge: made in Germany	7
1.2	Benefits of neodrives.....	8
1.3	The torque myth.....	12
1.4	What differentiates the neodrives rear motor from a mid-drive motor?	13
1.5	What changed comparison since the previous model?	14
2	Important notes – please observe!	15
3	The system	
3.1	Standard scope of delivery	17
3.2	Technical data	20
3.3	Factors affecting the remaining range	23
3.4	Starting the system	24
4	neoRemote & neoNode	
4.1	neoRemote	26
4.2	neoNode.....	27
5	neoMMIs	
5.1	How the neoMMI 20 works	28
5.2	How the neoMMI 20c works.....	34
6	Battery	
6.1	Overview and functions	42
6.2	Charging and storing the rechargeable battery	44
6.3	Removing and inserting the rechargeable battery.....	46
7	Motor	
7.1	Installation and removal of the rear wheel	48
7.2	Recuperation	50
7.3	Thermal management	51
8	Notes & troubleshooting	
8.1	Maximum axle load.....	52
8.2	Cleaning	52
8.3	Transport	53
8.4	Safety precautions	53
8.5	Error symptoms and possible measures	54

1 Introduction

Why the neodrive's rear motor?



1.1 Our pledge: made in Germany

93% of the starting materials are made in Germany, 100% of the final assembly takes place in Albstadt, Germany. We are deeply convinced of Germany as our primary production location and committed to maintaining this for the future.



At home in Germany

neodrives is the e-bike brand of Alber GmbH. Just under 300 employees develop and manufacture electric motors for the bicycle and rehabilitation industries.



Everything from a single source

The neodrives drive system is 100% engineered in-house, including complete assembly in Albstadt. Development focuses on maximum riding performance.



The Alber neodrives team

At Alber, our life revolves around bicycles. Many of our employees are bike enthusiasts, making them the best test riders.



Service

One of the best service ratings in the e-bike market means that our customers are quickly assisted in the event of a complaint, without the red tape.

Close and long-term relationships with our suppliers are very important to us. Together with our suppliers, our goal is to produce the best pedelec motor on the market, with a focus on outstanding driving characteristics. In the case of a malfunction or a complaint, the geographic proximity to our partners enables short response times and ensures that our customers are mobile again in no time at all.

1.2 Benefits of neodrives

Riding dynamics



No motor is as powerful, with equally smooth operation. Ideal for touring and trekking pedelecs, women's and city pedelecs, cool urban pedelecs and cargo pedelecs.

Why is riding with a neodrives rear motor more fun than with other motors?

The motor is positioned directly on the rear wheel and develops power right where it is needed. Any kind of power transmission, e.g. from the crank to the chain or the pinion, reduces the actual torque and efficiency and increases wear and tear. With the neodrives rear motor, the force acts directly on the rear wheel. The chain, pinion and other parts are not subjected to great strain, and there is a noticeable, direct response when accelerating.

The maximum torque of 40 Nm is always fully available to the rider, regardless of the gear selection. In contrast, the 75 Nm of a mid-drive motor are reduced by the gear ratio. On the rear wheel, the full torque is only reached at a gear ratio of 1:1 (very small gear). At the most commonly used gear ratio of approx. 2:1 (middle or large chainring at the front, middle pinion at the back), the torque is already halved, down to 37.5 Nm.

Sensitive force sensor for supremely smooth response – yo-yo effect practically eliminated

The force sensor is the interface between the pedelec rider and the drive system. The more sensitive the sensor, the smoother the ride. With this in mind, the force sensor has been taken to a whole new level compared to the previous version (neodrives Z15). With its extremely high sensitivity the sensor registers forces from as little as 0.5 Nm, significantly reducing the so-called “yo-yo effect”. As a result, power delivery is both strong and refined at the same time.

Unassisted riding noticeably improved

At speeds over 25 km/h and when riding at assistance level 0, the motor runs with considerably less effort than the previous version (neodrives Z15). However, as with all e-bikes, there is still some residual resistance, regardless of the position of the motor. Similar to a dynamo hub, all electric motors are subject to slight core losses.

Quietness



Less is more! In contrast to conventional mid-drive motors, there is no gearing in the neodrives rear motor, enabling entirely silent and vibration-free driving.

Enjoy nature in peace and quiet

A smooth ride is also a question of acoustics: motor assistance is not immediately betrayed by loud whirring. Users of neodrives rear motors appreciate its superior riding qualities and quiet performance.

Minimal maintenance



Long maintenance intervals for chain, pinion and gear system thanks to direct installation of the motor on the rear wheel. Both the components of the motor and pedelec are protected. The motor's electronics and its force and speed sensors are safely integrated inside the motor.

Why does the neodrive rear motor protect the gear system and chain?

- As the motor is installed on the rear wheel, it does not “tug” on the chain, unlike mid-drive motors.
- No elaborate hardware/software is necessary to detect gear shifts.
- A high-level of compatibility with standard bicycle components and long-term availability of spare parts are assured.

Energy recovery

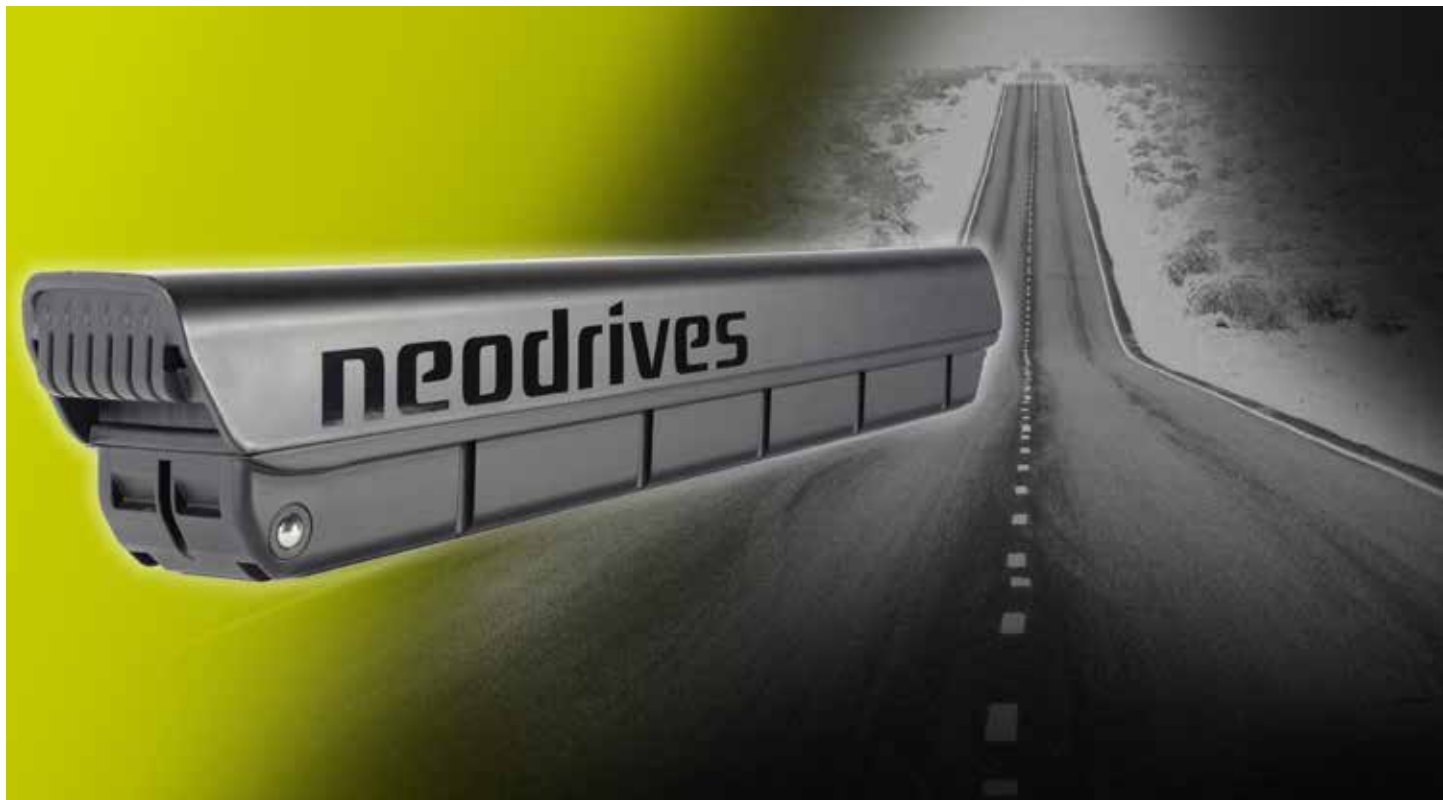

Recharge your batteries when riding downhill! This makes larger ranges possible, whilst taking the strain off the brakes.

Why does the neodrives rear motor have a range of over 100%?

- The powerful energy recovery, also referred to as recuperation, increases the battery range by 15% or more and now works up to approx. 45 km/h.
- The new machine development ensures high motor efficiency.

1.3 The torque myth

The rear motor has a transmission-independent performance

When comparing the data sheets of mid-drive motors you will find values of up to 90 Nm torque. This does not mean that mid-drive motors are more than twice as powerful as the neodrive rear motor. The torque that actually reaches the rear wheel from the mid-drive motor is significantly influenced by the gear selection. With a gear ratio of, for example, a 38-tooth chainring and a 19-tooth pinion – i.e. a range mostly used by the majority of riders – the torque on the rear wheel is already halved. Furthermore, internal gear hubs especially cannot withstand high torques continuously, which is why mid-drive motors are throttled ex works. Another drawback: with the high torque the chain is put under a lot of strain, which drastically reduces its life expectancy.

Our tip:

Test ride all systems. You will hardly notice a difference in power when comparing high-quality mid-drive motors with the neodrive rear motor. Thanks to the position of the motor in the rear wheel, the rear motor even seems to be significantly more powerful.

As mentioned earlier, the maximum torque of 40 Nm is always fully available to the rider, regardless of the gear selection. With the mid-motor the torque is reduced by the gear selection in such a way that only approx. half of the torque arrives at the rear wheel.

The torque of the mid-motor can be greatly reduced by the transmission ratio.

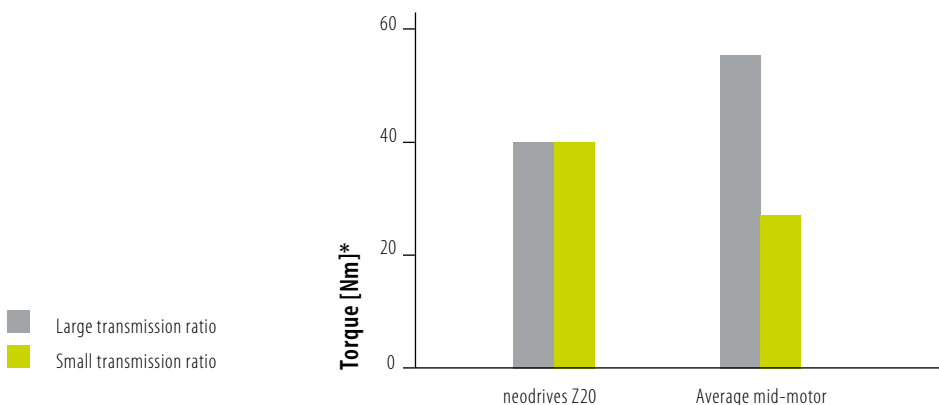

* At a speed of 18 to 25 km/h.

1.4 What differentiates a neodrives rear motor from a mid-drive motor?

Rear motor



neodrives rear motor

Silent, no disturbing noises from a gearbox

Powerful response and smooth performance thanks to the large motor installed directly on the rear wheel

Minimal wear of chain and gear system due to motor installed on the rear wheel

Recuperation when riding downhill saves the brakes and also recharges the battery

Extremely simple operation and compatibility with standard bicycle components – long-term availability of spare parts is assured

Mid-drive motor



CONVENTIONAL MID-DRIVE MOTOR

Noticeable noises from the gears installed in the motor

Delayed response; in some cases, jerky engagement of motor due to indirect coupling of motor and rear wheel

Increased wear of chain and gear system due to motor position in the middle – the motor “tugs” on the chain and gears, causing faster wear of both

No recuperation possible

Use of drive-specific components frequently required, e.g. crank or chainring

1.5 What has changed compared to the previous model?

Latest technologies

The heart of the neodrives rear motor system is the directly connected, gearless motor.

The goal of the new development was to make it even more robust, more powerful and smoother.

Thanks to the use of the latest technologies, this has been achieved to an exceptional degree.

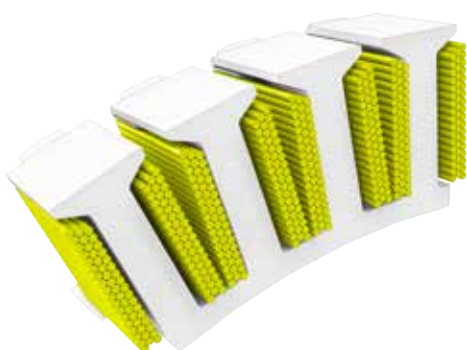

Machine development and updated electronics:

The performance of the neodrives rear motor has been optimised once again. At an efficiency of 85%, it far exceeds that of competitors and enables bikes to achieve even greater ranges.

Full compatibility and easy installation and removal of the motor:

The neodrives rear motor is compatible with all standard bicycle components, now also for 11-speed designs, stub axles and standard 6 V e-bike headlights. Long-term spare parts availability is assured. For approvals, please note the document in the downloads area: <https://www.neodrives.com/downloads.html>



High-quality workmanship, integration and design:

Slim motor connector, aluminium motor housing powder-coated with great care and finished with meticulous attention to detail – an attractive enhancement for every pedelec.

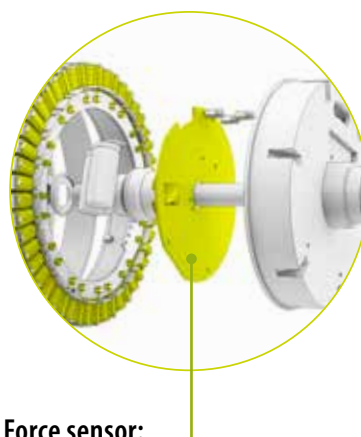

Force sensor:

The patented force sensor of the neodrives rear motor responds extremely smoothly and ensures exceptionally well-balanced performance.

2 Important notes – please observe!

In addition to this user manual, further documents are enclosed with your pedelec. Please observe the instructions and notes contained therein. There is currently no legal obligation to wear a helmet when using a pedelec. Nevertheless, it is advisable to wear a helmet for your own safety.

Intended use of neodrives components

Your pedelec, which is supplied with neodrives components by a specialist dealer,

- is designed as a trekking bike for normal person transport on public roads or as
- a mountain bike, which is specially designed for use off-road.

Settings and repairs to the pedelec and the individual components are only considered as intended use if they are explained and permitted in this user manual, in the user manual of the pedelec manufacturer, in the instructions of the component manufacturers or in other documents enclosed with the purchase of the pedelec.

The manufacturer accepts no liability for damage caused negligently by misuse, improper maintenance, improper repairs or improper use. It is the responsibility of the rider to check the pedelec as prescribed, to have any work done on it and to use it responsibly.

This user manual describes exclusively the use of the neodrives components attached to your pedelec and corresponds to the state of the art at the time of printing. The manufacturer reserves the right to make changes resulting from the further development of mechanics, software or legal requirements. The manufacturer regards the following cases as misuse of the neodrives components attached to your pedelec:

- Use of the drive system contrary to the instructions and recommendations of this user manual
- Exceeding the technical performance limits defined in this user manual
- Technical modifications to the neodrives components
- Changes to the software of the neodrives components
- Unauthorised attachment or unauthorised use of neodrives components on bicycles or any pedelec other than the one supplied to you

The manufacturer declines any liability for damage resulting from misuse of the components.

Before starting the journey, familiarise yourself with the safety and danger information in the individual chapters of these operating instructions and all other enclosed documents.

Explanation of symbols



Safety precautions

Warning of possible dangers to your health, indication of possible risks of injury; warning of possible technical problems or damage.

Always observe these precautions in order to avoid injury to persons and damage to the product.

Permissible operating conditions / locations for use

The neodrives components can be operated at temperatures between -20°C and $+45^{\circ}\text{C}$ → siehe Seite 22. In addition, observe the information on permissible operating conditions in the operating instructions of the pedelec manufacturer. Its restrictions of the permissible operating conditions (e.g. maximum climbing capability, maximum permissible obstacle height, maximum user weight) must also be observed when using the pedelec. Observe the safety and danger information in the individual chapters of these operating instructions.

3 *The system*



3.1 Standard scope of delivery

neodrives components

- neodrives rear motor
- neodrives neoNode (installed on the Pedelec)
- neodrives neoTwistlock and neoRemote (control element)
- neodrives display neoMMI 20 or 20c (display device)
- Cable harness
- This user manual

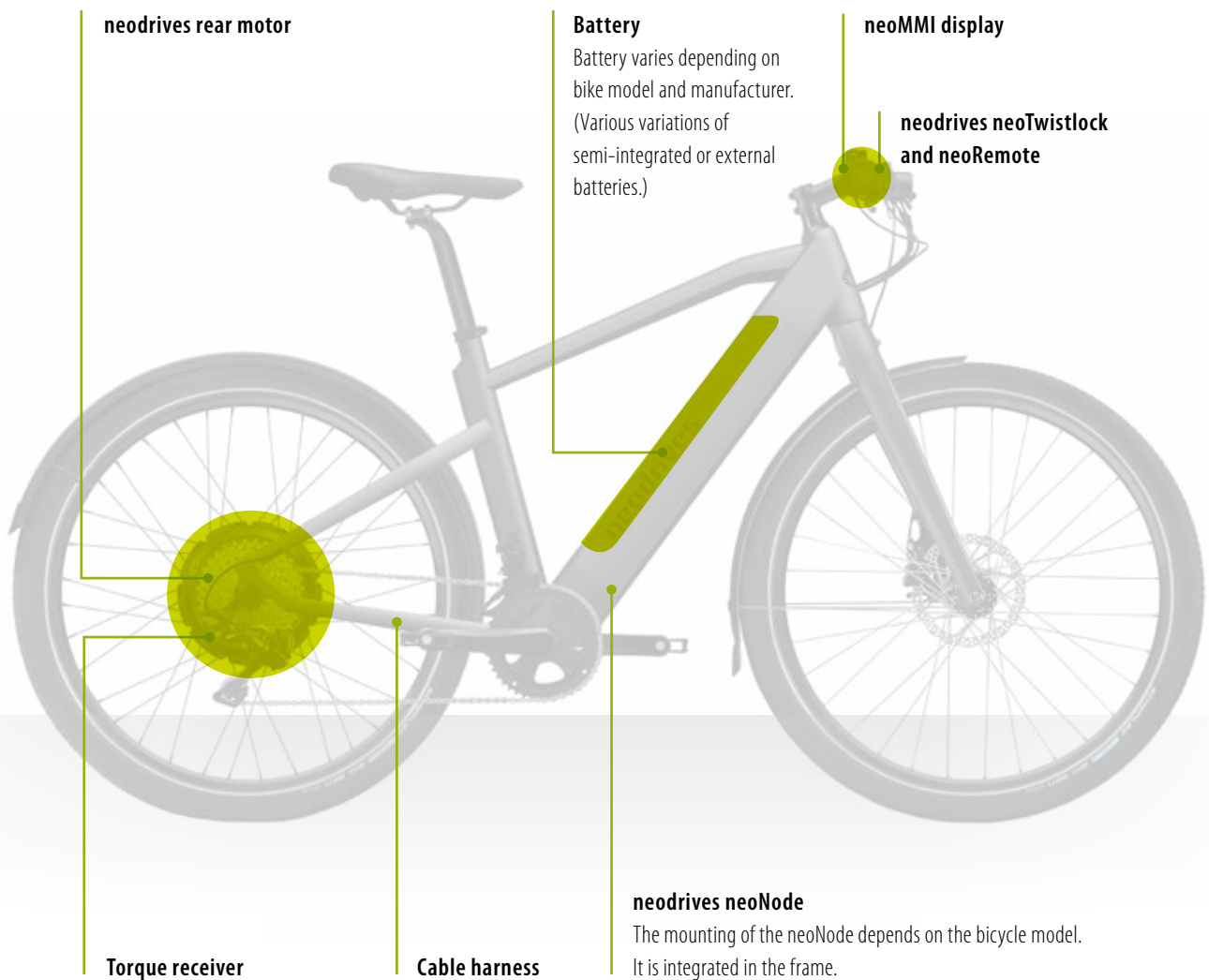

The neodrives Z20 drive system only has a few individual components. It can be combined with different types of displays and batteries.

Note: Example, the battery and its mounting may vary depending on the bike.

To optimise the overall system, completely new displays, battery management systems (BMS), motor electronics and plugs have been used. This means, for example, that the new Z20 neoMMI cannot be retrofitted



Important

The components of the new Z20 drive system are not compatible with the predecessor versions Z10/Z15, i.e. the system components cannot be interchanged.

to the Z15 system. Find out more about the Z10 and Z15 systems in the corresponding technical manuals, which are available for download online.

www.neodrives.com/downloads

Overview of Z20 system components

General components (same for every battery system)

1. Z20 rear motor as a hollow, threaded, stub axle version
 2. neoMMI 20c
 3. neoTwistlock with neoRemote
 4. Torque receiver (in different designs)
 5. **Alternative:** neoMMI 20
 6. Cable harness, available in different lengths
 7. Installation kit for neoTwistlock
- Optional battery system → see page 19



1. Rear motor Z20



2. neoMMI 20c



3. neoTwistlock with neoRemote



4. Torque receiver
(different designs)



5. neoMMI 20, model year 2018/19



6. Cable harness
(different designs)



7. Installation kit for neoTwistlock

Optional: system with external battery or semi-integrated battery

System with semi-integrated battery

Components for every battery system → see page 17

1. Battery UR V7, V8 (semi-integrated) incl. installation kit
2. neoNode with JST plug
3. Battery charger for UR V7 battery



1. Semi-integrated battery UR V7
The figure shows the UR V7 battery.
Other proprietary battery types available.



2. neoNode with JST plug (UR V7, UR V8)



3. Battery charger for UR V7 battery
Voltage: 42 V DC
Charging current: 4 A

System with external battery

Components for every battery system → see page 17

1. Battery UR V2, V5 (external) incl. installation kit
2. neoNode with neodrives plug
3. Battery rail for UR V2 battery
4. Battery charger for UR V2 battery



1. External battery UR V2



2. neoNode with neodrives plug



3. Battery rail for UR V2 battery



4. Battery charger for UR V2 battery

3.2 *Technical data*

Drive unit

Drive unit

Range	120 km
Speed	25 km/h
Power rating (peak)	250 W (650 W)
Operating voltage	36 V
Nominal torque	12 Nm
Peak torque	40 Nm
Efficiency	85% (incl. electronics)
Power electronics control system	Integrated in the wheel hub
Cassette hub	Conventional cassette, up to 11 speeds (Shimano MTB)
Brake disc	From a diameter of approx. 180 mm
Torque receiver	Torque receiver varies depending on dropout
Weight	4.2 kg (drive unit incl. freehub)

Displays and control unit

neoRemote (control elements) + neoTwistlock (mounting plate)

neoRemote	5 buttons: Power, Light, Set, Support Level + and –, 22.2 mm internal diameter, permanently wired
neoTwistlock	Handlebar mounting, angle adjustable in 15° steps
Weight (incl. cable and remote)	55 g

neoMMI 20 display

Display control	Monochrome
Display size	2 inch
Dimensions (W x L x H)	48 mm x 64 mm x 19 mm
Internal memory	4 GB
Interfaces	Connection to PC with diagnostic software
Mechanical/electrical contacting	Twistlock, corrosion-protected contacts, spring-mounted
Display type	LCD
Display screen	Reinforced, non-reflecting Dragontrail glass
Protection class	IP67
Display weight (removed)	51 g

neoMMI 20c display

Display control	Colour
Touchscreen	Rain and glove compatible
Softkeys	3 soft keys: Back, Home, Menu
Display size; resolution	2 inch, 240 x 320 Pixel
Dimensions w/o neoTwistlock (W x L x H)	48 mm x 64 mm x 19 mm
Internal memory	4 GB
Connectivity	Bluetooth classic/smart
Interfaces	Connection to PC with diagnostic software
Mechanical/electrical contacting	Twistlock, corrosion-protected contacts, spring-mounted
Display type	TFT
Display screen	Reinforced, non-reflecting Dragontrail glass
Protection class	IP67
Display weight (removed)	54 g

Battery

The neodrives rear motor is available in combination with different battery types. These vary in capacity, size and shape. Please observe the separate user manual for the battery.

	V2	V5	V7	V8
Type	External battery	External battery	Semi-integrated battery	Semi-integrated battery
Type of rechargeable battery	Lithium-ion	Lithium-ion	Lithium-ion	Lithium-ion
Cell	INR18650 35E	INR18650 M36	INR18650 35E	INR18650 M36
Nominal capacity	17 Ah	14 Ah	14 Ah	17 Ah
Voltage	36 V	36 V	36 V	36 V
Energy content	621 Wh	500 Wh	500 Wh	625 Wh
Range	145 km	120 km	120 km	145 km
Weight	Approx. 3.5 kg	Approx. 2.8 kg	Approx. 2.9 kg	Approx. 4.1 kg
Place of charging	On the bicycle or removed from the bicycle	On the bicycle or removed from the bicycle	On the bicycle or removed from the bicycle	On the bicycle or removed from the bicycle
End-of-charge voltage	42 V	42 V	42 V	42 V
Battery charger	4 A	4 A	4 A	4 A
Protection class	IP54	IP54	IP54	IP67
Operating ambient temperature	-10°C to 60°C	-20°C to 60°C	-10°C to 60°C	-20°C to 60°C
Maintenance/storage				
Air temperature	18 – 23°C	10 – 25°C	18 – 23°C	22 – 26°C
Humidity	0 – 80%	0 – 65%	0 – 80%	-
Charging status	70%	50% (+/- 10%)	50%	50%

Total system

Operating temperature	-20°C to +45°C (depending on battery, see above), below 0°C the recuperation or battery charger is deactivated automatically
Protection class	IP65

We reserve the right to make changes in technology and design due to on-going further developments.

3.3 Factors affecting the remaining range



The neodrives motor is designed to be highly efficient and achieves an efficiency level of approx. 82% in the speed range from 20 to 25 km/h. Since it is a direct rotor (no gear as for example with mid-engines), only small losses occur. The range that can be achieved by the rider is subject to many influencing factors.

These are the main ones:

- **Topography:** Travelling on hilly terrain visibly affects the battery more than travelling on flat terrain.
- **Weather:** On cold days the battery range can be 30-40% lower than on warm days. Head wind also has an influence on power consumption.
- **Frequent acceleration/travelling at low speeds:** Large amounts of power are needed to accelerate. Comparable with the high instantaneous fuel consumption occurring on a car when starting off.
- **System weight:** This factor is often underestimated. The weight of the rider and their belongings contribute considerably to the overall mass of the bike (this is different in the case of a car).
- **Rider's effort:** The more effort the rider puts in, the higher the achievable range. It often helps to switch down 1-2 gears to increase the input force or the cadence.
- **Tyre pressure:** If the tyre pressure is too low, the friction between the tyre and the ground surface is increased, which can lead to a loss of several percentage points.

3.4 Starting the system

Connecting the display with neoTwistlock

1. neoTwistlock is mounted.
2. Set the display at a 90° angle, turn clockwise to open it
3. Finished

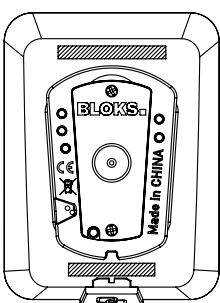

The USB charging port or the softkeys (only for the TFT display) are located at the bottom.

Removal

Turn the display on the mounting plate approx. 90° counterclockwise. The electrical connections are disconnected and the display can be removed. Before removing, the system (display + pedelec) should be switched off → see chapter 4.1. However, there will be no damage if you mount or dismount the display while the pedelec is switched on.

Notes:

To protect your pedelec from accidental use by third parties or theft, the display should always be removed from the handlebar when not in use. However, removing the display does not replace securing your pedelec against theft, e.g. with a suitable bicycle lock. The system should be switched off before removing it. However, there will be no damage if you mount or dismount the display while the pedelec is switched on. Approximately 15 seconds after turning, the system goes off. The light, if switched on, also switches off after approx. 15 seconds. After turning off the display, wait approx. 30 seconds until you put it back on again. Otherwise, a successful system initialisation cannot be guaranteed.

Fixing the display on the Twistlock

If required, you can attach the display to the Twistlock. Use a 1.5 mm Allen key to do this.



Switching on external battery UR-V2, V5

- Press the battery button.
- Press and hold the on/off button on the remote for one second. Wait until the trip screen appears; this can take up to 5 seconds.



External battery: press the battery button. Battery button position may vary.



System on/off

Switching on semi-integrated battery UR-V7, V8

- Press and hold the on/off button for one second. Wait until the trip screen appears; this can take up to 5 seconds. It is not necessary to press the battery button beforehand.



Switch the battery on using the on/off button on the system. The screen takes a few seconds to display the start screen.



Semi-integrated battery with battery button: no need to press the battery button.

Notes:

Please unload the pedal during switch-on. Do not pedal until the display is up. If you switch on the display while riding, release the pedal for 3 seconds to start motor assistance. Please remember to switch off the pedelec after each ride using the local control panel. It is not automatically switched off.

4 neoRemote and neoNode

4.1 neoRemote



The neoRemote on the left-hand side of your pedelec's handlebar allows you to make adjustments to your pedelec at any time, such as the degree of pedal assistance, without taking your hands off the handlebar.

"+" button

- Increase the assistance level by pressing the button
- Activate the pushing aid (4 km/h) by pressing and holding the button for 3 seconds

"-" button

- Decrease the assistance level
- Activate recuperation



SYSTEM ON/OFF

LIGHT ON/OFF

"SET" BUTTON:

- Scroll through the display menu (neoMMI 20c)

4.2 neoNode

- Main task: communication interface between battery/motor and display
- In the down tube or in the vicinity of the bottom bracket
- Small, robust plugs for quick disassembly



neoTwistlock plug connection



Note on plug mounting plate

If you have to open the 2 plugs of the cable leading from the neoTwistlock mounting plate to the frame, observe the following instructions when assembling.

The male plug from the mounting plate (see illustration above left) and the female plug on the connecting cable (see illustration above right) must be correctly aligned when joining. Both plugs are marked. Align the markings (see illustration in the middle) and carefully push the plugs together (see illustration below). If the plugs are not aligned correctly, they may be damaged during assembly.

When unplugging and plugging in, only grip the plugs, not the cable. Do not bend the cable when assembling the plugs to avoid damaging it!

Connecting a headlight

The system provides a current output for e-bike lights. Only approved lights may be connected to the neodrive system. Please refer to the list of currently approved lights at www.neodrives.com/en/dealer-login/.

The front light is connected directly to the cable harness. The rear light must be supplied via the front light. The list is constantly being expanded.



Safety precautions

Connecting other headlights may lead to system errors.

5 neoMMIs

Either a neoMMI 20 or a neoMMI 20c can be mounted on your pedelec as a display (previous year: BLOKS Display 20 and BLOKS Display 20c). Using the neoRemote (→ see chapter 3), you can call up various functions and make settings. The respective display is mounted on the neoTwistlock (mounting plate).

The neoDisplay 20 has a monochrome 2-inch LCD display. It is a pure display that is only operated via the remote. The neoDisplay 20c is equipped with a colour, 2-inch TFT display with 3 softkeys. This display can be operated with the remote as well as with the touchscreen of the display and the 3 softkeys.

The display has a micro-USB port at the bottom, under a rubber cover. The port is primarily intended for specialist dealers, e.g. to carry out diagnostic work or firmware updates. Make sure that the rubber cover at the bottom is always fully inserted and seals the connection. If the display is not completely sealed, moisture may get inside or damage the display.

5.1 How the neoMMI 20c works

Display

The neoDisplay 20 has an LCD display (liquid crystal display).

Note: The figure shows all segments of the display. A typical display while riding does not show all segments simultaneously.

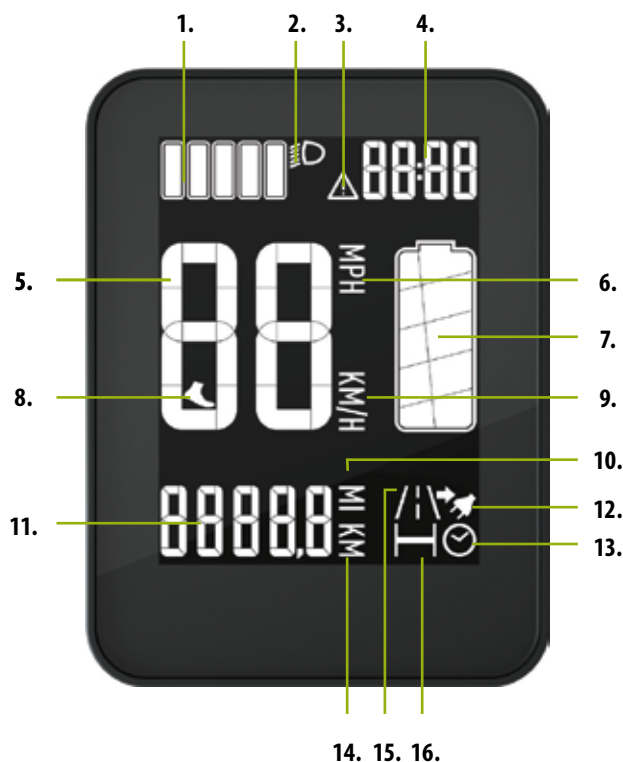

No. Function

- | No. | Function |
|-----|---|
| 1. | Assistance mode and recuperation → siehe Seite 30 |
| 2. | Headlight on → siehe Seite 31 |
| 3. | Warning triangle → siehe Seite 31 |
| 4. | Time → siehe Seite 31 |
| 5. | Current speed → siehe Seite 31 |
| 6. | MPH: miles per hour → siehe Seite 32 |
| 7. | Battery state of charge → siehe Seite 32 |
| 8. | Pushing aid → siehe Seite 32 |
| 9. | KM/H: kilometres per hour → siehe Seite 31 |
| 10. | MI: miles → siehe Seite 32 |
| 11. | Values for trip distance, odometer, travel time, range → siehe Seite 32 |
| 12. | Range → siehe Seite 33 |
| 13. | Travel time → see page 33 |
| 14. | KM: kilometres, MI: miles → siehe Seite 32 |
| 15. | Trip → siehe Seite 32 |
| 16. | Odometer → siehe Seite 33 |



Display 20: menu

1. Press the "Set" button on the operating unit for approx. 3 seconds to access the menu. You can change the time and measurement unit settings.
2. By briefly pressing the "Set" button again you can move from one menu item to the next.
3. To change a setting in the menu, press "+/-" on the remote.
4. To exit the menu, press the "Set" button for 2 seconds or start pedalling.

Assistance mode

(No. 1 on screen)

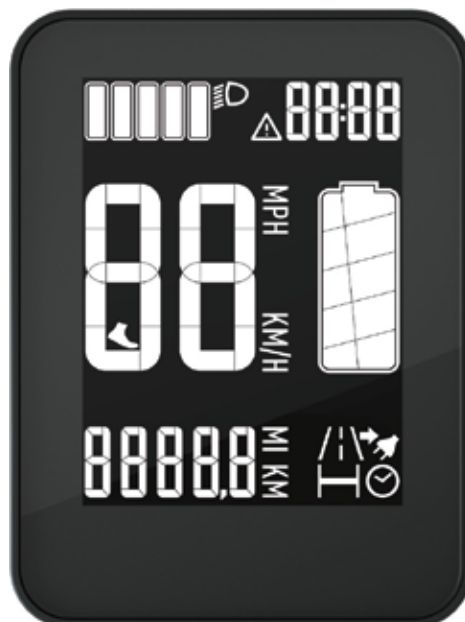









1. Select the level of assistance you require by briefly pressing the "+/-" button.
2. If you are on levels 1 to 5 and pedalling, you are assisted by the motor. As soon as you stop pedalling or a speed of 25 km/h is reached, the assistance automatically switches itself off.
Recuperation stage 1: Recuperation works at low power.
Recuperation stage 2: Recuperation works at high power.



To enter recuperation, e.g. when riding downhill, press “-” on the rocker switch to switch from level 0 further down. So that you do not confuse the 2 recuperation levels with the assistance levels, the battery symbol is animated during recuperation: A black field moves from top to bottom (see left). Using “+” on the rocker switch takes you up to the assistance levels.

You can vary the degree of pedal assistance at any time with “+” and “-” on the rocker switch on the neoRemote to make optimum progress in all situations and terrains. There are five assistance levels, level 0 = “Off”. and two recuperation levels where the battery is recharged. The symbols for the 8 levels are shown in the table.

Display	Assistance	Power consumption
	Level 5 Assistance works at very high power.	Very high
	Level 4 Assistance works at high power.	High
	Level 3 Assistance works at medium power.	Medium
	Level 2 Assistance works at low power.	Low
	Level 1 Assistance works at very low power.	Very low
	Level 0 No assistance	Minimum (only standby power)
	Recup. 1 Recuperation stage 1: Recuperation works at low power.	
	Recup. 2 Recuperation stage 2: Recuperation works at high power.	



Display of the battery symbol when recuperation is active

Note

Pedal assistance only lasts as long as you pedal. If you stop pedalling, the motor will stop assisting you.

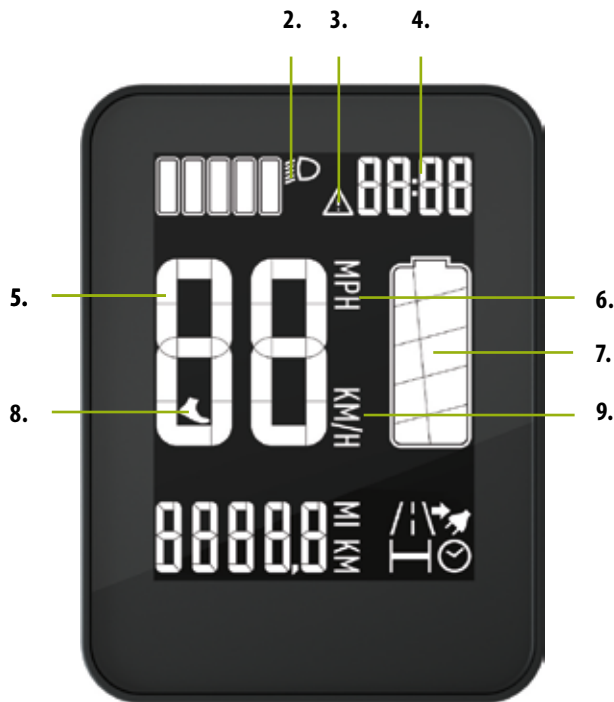

Switching on the headlight

(No. 2 on screen)

When you have switched on the headlight using the light button on the operating unit, the light symbol appears at the top of the display. When the headlight is switched on, the background lighting on the LCD display is also activated, making it easy to read in the dark.

Warning triangle

(No. 3 on screen)

The warning symbol appears as soon as an error occurs in the system or the end of the service interval has been reached. Please contact your specialist dealer so that they can analyse the message.

Time

(No. 4 on screen)

Time is displayed in 24-hour format. To set the time, press the "Set" button for 2 seconds. You can then set the time using the "+" and "-" buttons. To exit the menu, press the "Set" button again for 2 seconds or start pedalling.

Current speed

(No. 5, 6, 9 on screen)

You can display the speed that you are travelling at in kilometres per hour (km/h) or miles per hour (mph).

Battery state of charge

(No. 7 on screen)

The battery symbol shows the battery state of charge in 5 levels. Please bear in mind that each level shows a range of 20%. If, for example, 3 of 5 levels are shown, this means that the battery charge is between 40 and 60%.

Pushing aid

(No. 8 on screen)

When the pushing aid is activated, the symbol appears on the display. To activate the pushing aid, start moving the bike and hold the "+" button for 3 seconds. Keep the "+" button pressed for as long as you wish to be assisted by the motor.

Trip, odometer, travel time, range

With a brief press on the "Set" button on the operating unit you can switch between trip distance, odometer, travel time and range in the lower part of the display.



Units for selection

Speed (km/h, mph)

(No. 6 / No. 9 on the screen)

It is possible to switch between metric or imperial view on the display. In the metric format, the speed is displayed in kilometres per hour (km/h), the distance in kilometres (km) and the time in 24-hour format. If the imperial units display is selected, the speed is displayed in miles per hour (mph).

Distance (mi/km)

(No. 10 / No. 14 on screen)

When the imperial units display is selected, the distance is displayed in miles (mi).

Press the "Set" button for 2 seconds and select the km display by pressing the "Set" button again. Set the desired format by pressing the "+" or "-" button. Exit the menu by pressing the "Set" button again or by starting to pedal.

Time

(No. 13 on screen)

When the imperial units display is selected, the time is displayed in 12-hour format.



Trip

(No. 15 on screen)

Shows the distance you have travelled since the trip counter was last reset.



Odometer

(No. 16 on screen)

Shows the whole distance travelled by the pedelec. This indicator cannot be reset to "0".



Travel time

(No. 13 on screen)

Shows the time that you have ridden since the trip counter was last reset.



Range

(No. 12 on screen)

Shows the remaining range that can be reached without charging the battery in the meantime.

The range shown varies depending on the assistance level selected. **Example:** On level 5 the range is lower than on level 1 → .see page 30 The distance shown in the display may vary from the actual range.



Resetting the trip counter

To reset the trip counter, press the "-" button for approx. 3 seconds when the pedelec is at a standstill. This will reset the trip distance and travel time.



The "-" button on the Remote to clear the trip counter

5.2 How the neoMMI 20c works



Softkeys

1. 2. 3.

The neoMMI 20c is equipped with a 2-inch colour TFT display with 3 softkeys (keys on touch display). This display can be operated with the handlebar unit neoRemote (→ see chapter 4) as well as with the touch screen of the display and the 3 softkeys.

Softkeys

There are 3 softkeys at the bottom of the TFT display. The functions of the buttons are, from left to right, “Back”, “Home” and “Menu”. The triangular “Back” button takes you back to the previous selection within the menus. The round “Home” button takes you to the main display. The main display is the starting point of the display, which has a total of 3 display modes.

The square “Menu” button opens and closes menus. You can make various settings in the menus. For example, you can specify whether the speed is displayed in kilometres per hour (km/h) or miles per hour (mph).

3 Display types

The display has 3 display modes: the main display, the power display and the trip display. Use the “Set” button on the neoRemote handlebar control (→ see chapter 2) to switch between these displays. Press the “Home” button to return directly to the main display at any time.

Main display



Trip screen



Power screen



No. / Name	Function
Housing	
1. Back	a) Within the menus, takes you back to the previous selection, or alternatively press the "Set" button on the remote b) Switches between the 3 display types
2. Home	Takes you to the main display
3. Menu	Opens and closes menus
Main display screen	
4. Headlight	→ SIEHE SEITE 36
5. Time	→ See page 40
6. Speed	→ See page 41
7. Pushing aid	→ See page 41
8. Assistance	Assistance mode and recuperation → see page 41
9. Range	Discussed under the "battery" menu item → see page 39
Trip display screen	
10. Trip	Discussed under the "Trip" menu item: shows the distance you have travelled since the trip counter was last reset → siehe Seite 37
11. Travel time	Discussed under the "Trip" menu item: shows the time you have ridden since the trip counter was last reset → siehe Seite 37
Power display screen	
12. Ratio	From pedal power (left bar) to motor assistance (right bar) → see page 41
13. Kilocalories	Average calculated calorie consumption
14. Cadence	Pedal rotations per minute



Menu

1. To access the menu, please press the “Menu” button briefly.

Menu item selection

Trip > reset trip

Inspection

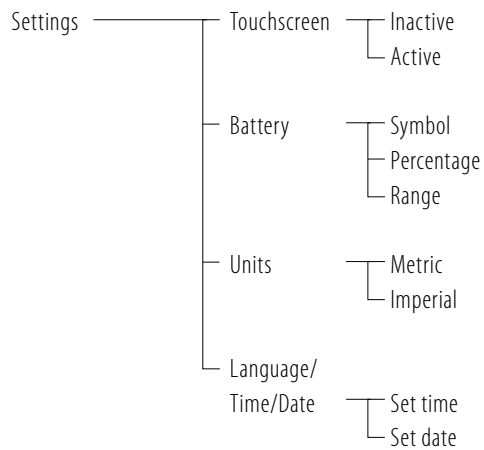

2. Select the desired menu item by tapping the display. You will reach the corresponding sublevel.
3. To exit the menu, please press the “Menu” or “Home” button. You will go back to the main display.



Headlight

When you have switched on the headlight using the light button on the remote, the light symbol appears at the top of the display. The bicycle headlight is activated. If there is a switch on the light itself, check that it is in the “ON” position.



Trip menu item

1. Tap the menu item "Trip" in the main menu. This will take you to sublevel 1, where the following menu items are displayed:

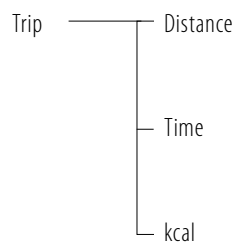

2. To reset the 3 values shown for distance, time and kcal to "0", tap "Reset".
3. To go back to the main menu, tap "Trip" at the top or press the "Menu" or "Back" button.
4. If you want to go straight back to the main display, press the "Home" button.



Inspection menu

Touching the "Inspection" menu item in the top level takes you to this menu item. The following are displayed: the frame number, when the next inspection is due, how often the battery has been charged, and the total distance the pedelec motor has covered so far (odometer – this information cannot be reset to "0").

You can return to the top level of the menu either by tapping "Inspection" at the top or by tapping the "Back" button at the bottom left (→ see chapter 5.2). Or you can leave the menus completely by tapping the round "Home" button at the bottom centre. This will take you to the main display (→ see page 35).

1. Tap the "Inspection" menu item in the main menu. This will take you to sublevel 1, where the following menu items are displayed:

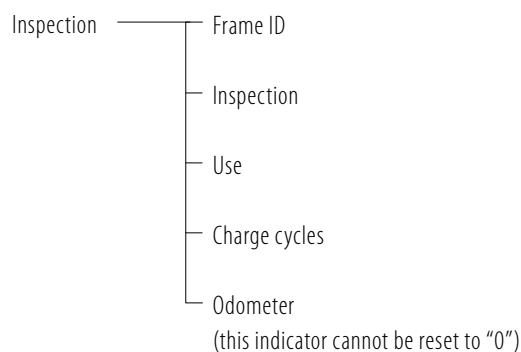

To go back to the main menu, tap "Inspection" at the top or press the "Menu" or "Back" button.

2. If you want to go straight back to the main display, press the "Home" button.



Settings menu item

1. Tap the menu item “Settings” in the main menu. This will take you to sublevel 1, where the following menu items are displayed:

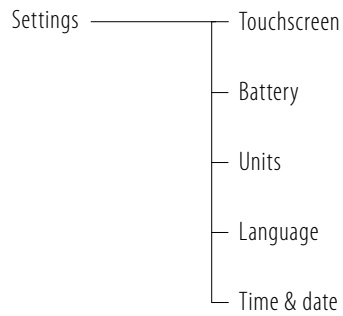

2. You can select and tap one of the 5 menus displayed. This will take you to the next sublevel.
3. To go back to the main menu, tap “Settings” at the top or press the “Menu” or “Back” button.
4. If you want to go straight back to the main display, press the “Home” button.



Touchscreen menu

In this menu item you can set whether the touchscreen should be active or inactive while riding. This may be useful to prevent accidental operation during the ride.



Safety precautions

If you use the “Always active” setting and try to change settings during the ride, this may not only lead to operating errors but it can also distract you from your ride. This can have dangerous consequences – your safety is a priority!

1. Tap “Touchscreen” in sublevel 1.
This will take you to sublevel 2, where the following menu items are displayed:

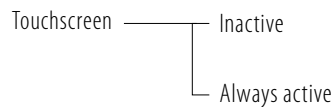

2. Select the desired menu item.
3. To go back to sublevel 1, tap “Touchscreen” at the top or press the “Back” button.
4. If you want to go straight back to the main display, press the “Home” button.



Battery menu item

In this menu you can set whether the battery state of charge should be shown as a symbol or as a percentage with the range. This indicator also varies in the menu depending on the assistance level selected.

Example: The range is lower on level 5 than on level 1
→ see page 45.

Note: The distance shown in the display may vary from the actual range.

1. Tap the "Battery" item in sublevel 1. This will take you to sublevel 2, where the following menu items are displayed:

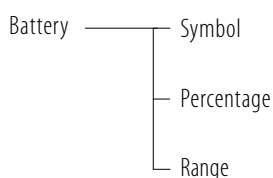

2. Select the desired menu item. A tick appears next to your selection.
3. To go back to sublevel 1, tap "Battery" at the top or press the "Back" button.
4. If you want to go straight back to the main display, press the "Menu" button.



Units menu item

In this menu you can set whether you prefer metric units (kilometres per hour [km/h] and a 24-hour clock) or imperial units (miles per hour [mph] and a 12-hour clock), to be used in the display.

1. Tap the "Units" item in sublevel 1. This will take you to sublevel 2, where the following menu items are displayed:

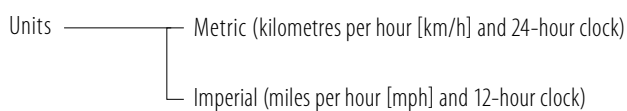

2. Select the desired menu item. A tick appears next to your selection.
3. To go back to sublevel 1, tap "Units" at the top or press the "Back" button.
4. If you want to go straight back to the main display, press the "Home" button.



Language menu item

In this menu you can set the language shown in the display. Six languages are currently available at the time of writing these instructions: English, German, French, Spanish, Italian and Dutch.

1. Tap "Language" in sublevel 1. This will take you to sublevel 2.
2. Select the desired menu item. A tick appears next to your selection.
3. To go back to sublevel 1, tap "Language" at the top or press the "Back" button.
4. If you want to go straight back to the main display press the "Menu" button.



Time & date menu item

In this menu, you can set the time and date shown in the display.

1. Tap "Time & date" in sublevel 1. This will take you to sublevel 2.

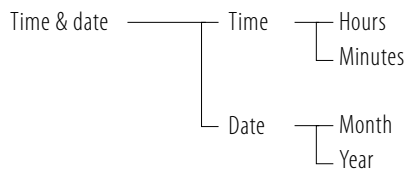

2. Tap "Time" or "Date". Sublevel 3 will appear.
3. Tap to determine which of the two fields is active. The active field has a white background with a light green border at the bottom, whereas inactive fields are light grey. The "Time" menu gives the options of hours and minutes, whilst the "Date" menu can be used to set the day, month and year.
4. You can select the required values using the "+" and "-" symbols at the bottom of the display.
5. To go back to sublevel 2, tap "Date" at the top or press the "Back" button.
6. If you want to go straight back to the main display, press the "Home" button.





Speed

It is possible to switch between metric or imperial view on the display. In the metric format, the speed is displayed in kilometres per hour (km/h), the distance in kilometres (km) and the time in 24-hour format. If imperial units are selected, the speed is displayed in miles per hour (mph), the distance in miles (mi) and the time in the 12-hour format. Select the desired display from the "Units/Settings" menu on the touchscreen → see page 39. A small tick will show you which display has been selected.

Pushing aid

When the pushing aid is activated, the symbol appears on the display. To activate the pushing aid, start moving the bike and hold the "+" button for 3 seconds. Keep the "+" button pressed for as long as you wish to be assisted by the motor.



Assistance mode and recuperation

1. Briefly press the "+/-" key to select the level of assistance you want or the level of recuperation you want to activate.

Activation of recuperation

Press the "-" button until the digits 1 and 2 appear in the display with an energy symbol.

Recuperation level 1: The motor recovers energy. 50% of the permitted recuperation power is generated.

Recuperation level 2: The motor recovers more energy. 100% of the permitted recuperation power is generated.

Display	Assistance	Power consumption
Assistance level 5	Assistance works at very high power.	Very high
Assistance level 4	Assistance works at high power.	High
Assistance level 3	Assistance works at medium power.	Medium
Assistance level 2	Assistance works at low power.	Low
Assistance level 1	Assistance works at very low power.	Very low
0 (off)	No assistance	–
Recuperation level 1	No assistance	Energy recovery
Recuperation level 2	No assistance	Energy recovery

→ See page 26

2. The motor will assist you according to the selected assistance level as long as you are pedalling. As soon as you stop pedalling or a speed of 25 km/h is reached, the motor will stop assisting you.

6 Battery

6.1 Overview and functions



External battery UR V2



External battery UR V5

Battery LED display/battery button

This information applies to the external batteries UR V2 and V5, the semi-integrated battery UR V7 and the semi-integrated battery Integrale 0.5. The position of the battery button depends on the model: on the side of battery UR V2; on the top of battery UR V7; and on the lower part of battery Integrale 0.5, the battery must be removed.

Using the battery button on the top or side of the battery you can call up the following information or carry out the following actions:

- Switch on the battery
- Check the battery's state of charge
- Set the battery to deep sleep mode
- Waking the battery from deep sleep

To ensure correct functioning of the display, the battery must be disconnected from the system beforehand if necessary (unplug the battery or remove it from its frame).



Semi-integrated battery UR V7

Switching on the battery

External battery (UR V2/V5):

If the system has been used in the last 4 hours, it will be in standby mode. In this case the system can be switched on by pressing the on/off button on the remote. If it has not been used for a long time (maximum 4 hours) the battery assumes deep sleep mode to reduce standby power to a minimum. To "wake" the battery from deep sleep mode, the battery button must be pressed for approx. 1 second. The battery is then ready for use and the display can be switched on.

Semi-integrated battery:

Semi-integrated batteries have a so-called wake line. These batteries do not need to be woken up by pressing the battery button, but a press of the on/off button on the display remote is enough.



Semi-integrated battery UR V7

Checking the current state of charge

Press the battery button briefly: the battery's state of charge will be shown

- 5 LEDs lit: battery has 80-100% charge.
- 4 LEDs lit: battery has 60-80% charge.
- 3 LEDs lit: battery has 40-60% charge.
- 2 LEDs lit: battery has 20-40% charge.
- 1 LED lit: battery has 0-20% charge.
- 1 flashing LED: battery is flat.

Set the battery to deep sleep mode

Keep the battery button pressed for more than 5 seconds: The LEDs shut down one after the other 5-4-3-2-1-0. When the last LED has gone out, keep the battery button pressed for another 2-3 seconds. Within the next 60 seconds, the battery assumes deep sleep mode. Information: Depending on the battery type, the battery automatically assumes "deep sleep" mode within max. 4 hours of disuse (display off, battery button not pressed). In this status the standby power consumption is reduced to a minimum, to enable longer storage periods without a great loss of capacity, for example.



Semi-integrated battery UR V8

Waking the battery from deep sleep

After switching off the pedelec and unplugging the charging plug, the battery goes into deep sleep mode to reduce the standby power to a minimum. Press the battery button briefly to wake the battery up again. All 5 LEDs will light up, followed by a brief pause after which all LEDs will flash three times. The battery is now operational again.

Only use the battery charger provided to charge the battery. Use of an unsuitable battery charger may lead to malfunctions and result in a reduced battery service life. There is also a risk that it may catch fire or explode. The battery can be charged on the bike or when removed from the bike. Connect the plug on the battery charger to the mains first before connecting the battery.

The battery can remain in the pedelec during charging. Alternatively, you can remove the battery and charge it outside the pedelec.

6.2 Charging and storing the rechargeable battery



Battery charging, plugging in battery charger, UR-V2 battery



Battery charging connection, battery UR-V5

The battery can remain in the pedelec during charging. Alternatively, you can remove the battery and charge it outside the pedelec.

Charging the battery

1. Connect the power cable to the battery charger
2. Connect the charging plug to the charging socket of the battery until it clicks into place
3. Plug the mains plug into a socket. After approx. 5-10 seconds the green LED flashes fast and evenly. If the display is connected to the pedelec, it turns on for a few seconds before automatically turning off again.
4. When the battery is fully charged, the battery charger switches off. The green LED on the battery charger lights up continuously. The LEDs on the battery go out.

**The position of the battery button depends on the model:
on the side of battery UR V2; on the top of battery UR V5, V7, V8
and on the lower part of battery Integrale 0.5, battery must be removed.**

After approx. 5 seconds the LEDs on the battery will light up as follows:

- All 5 LEDs flash in turn: battery is on charge, the state of charge is between 0 and 20%.
- 1 LED is permanently lit, LEDs 2-5 flash in turn: battery is on charge, the state of charge is between 20 and 40%.
- 2 LEDs are permanently lit, LEDs 3-5 flash in turn: battery is on charge, the state of charge is between 40 and 60%.
- 3 LEDs are permanently lit, LEDs 4-5 flash in turn: battery is on charge, the state of charge is between 60 and 80%.
- 4 LEDs are permanently lit, LED 5 flash is flashing: battery is on charge, the state of charge is between 80 and 100%.
- When charging is complete, all LEDs will go out and the battery will be set to deep sleep mode as soon as the charging plug is removed. To “wake up” the battery, press the battery button once.



Battery charging, plugging in battery charger, UR-V7 battery

Storing the battery

- When removing the battery, ensure that it will be stored dry and protected from foreign particles (e.g. metal shavings).
- The state of charge should be 50-70%.
- When the battery is in storage, check its state of charge every 3 months and charge to 70% when necessary.
- Do not expose the battery to any moisture (water, rainwater, snow, etc.) during storage.
- Store the battery in a cool, dry place where it is protected from damage and tampering.

For optimum battery life, the battery should be stored at a temperature of 18°C to 23°C and a humidity of 0 to 80% (→ see page 22).



Battery charging, semi-integrated battery UR-V8

Battery charger display

Green LED flashes approx. 1x per second	Charging
Green LED permanently lit	Battery fully charged, charging complete
Green LED flashes briefly every 2 seconds	No battery connected, battery not charging
Red LED flashes	Charging error

In the event of a charging error please check for kinks in the cables and ensure that the plug is clean and fitted correctly. If the battery charger has a magnetic plug: check the magnetic plug on the battery charger and the magnetic socket on the battery for dirt from time to time and in the event of any problems during charging. Metal shavings and small parts like washers can easily gather there due to the magnet.

Regarding the charging time: the battery charger produces a charging current of 4 A on average. This means that over a complete charging cycle (completely empty battery – completely charged battery) it charges with an average of 4 A.

6.3 Removing and inserting the battery



Inserting the semi-integrated battery UR-V8

Semi-integrated battery UR V8

To release the battery, turn the key anticlockwise until it will go no further. Operate the locking mechanism and remove the battery from the bottom tube. Caution: Depending on how the battery is attached, make sure that the battery does not fall out.

Turn the key back to its original position and remove it. If the key is left in the lock, there is a risk of it breaking, e.g. when the crank is turned. You do not need the key to insert the battery. If the key is still in the lock, please remove it. Insert the battery and press down until you hear and feel it click into place.



Inserting the external battery UR-V5

External battery UR V5

To release the battery, turn the key clockwise until it will go no further. The lock is now open, the battery can be turned sideways out of the rail. To insert the battery, open the battery lock if necessary. Position the lower end of the battery in the battery rail and rotate the battery fully into the socket until it clicks into place. Carefully remove the key.



Inserting the external battery UR-V2

External battery UR V2

To release the battery, turn the key clockwise until it will go no further. The lock is now open and the battery can be pushed up from the rail. Some force may be required to do this. To insert the battery, open the battery lock if necessary.

Tip: You can tell if the battery lock is open from the retracted battery hook under the battery. The key can only be removed when the battery is locked. Push the battery along the battery rail and turn the key anticlockwise until it will go no further. Carefully remove the key.



There are 2 battery keys in the standard scope of delivery. Example V5.



Inserting the semi-integrated battery UR-V7

Semi-integrated batteries UR-V7 and Integrale

To release the battery, turn the key anticlockwise until it will go no further. The battery can be removed. Please turn the key back to its original position as soon as you have removed the battery and remove the key from the lock. If the key is left in the lock, there is a risk of it breaking, e.g. when the crank is turned. You do not need the key to insert the battery. If the key is still in the lock, please remove it. Insert the battery and press down until you hear and feel it click into place.

Key number

Prior to delivery of the pedelec, please note the key numbers and the manufacturer, e.g. in the bike book or the user manual. With the help of the key number, keys can be ordered directly from the key manufacturer. If the key number is not noted and both keys are lost, a new lock will have to be installed.

7 Motor

7.1 Installation and removal of the rear wheel



The drive wheel of your pedelec can be removed from the bicycle frame at any time for cleaning purposes or in the event of a flat tyre. Please proceed extremely carefully during removal and the subsequent assembly. Pay special attention to the instructions and specifications of the manufacturers of the various components attached to the wheel, in particular the brake disc.

Removing the drive wheel

Make a note of the cable routing and the fixing points of the cable ties before removing the drive wheel. First loosen and remove all cable ties that attach the cable coming from the motor as well as cables and supply lines from other components to the bicycle frame.

1. Open the rim brake, if one is installed.
2. Shift to the smallest pinion if a derailleur is fitted.
3. Release the rear wheel from the frame while holding it firmly.
4. Now remove the torque receiver from the motor and pull the plug out of the motor. You can now remove the rear wheel completely.



Safety precautions

Pay attention to the mounting position of the torque receiver. When refitting the wheel later, it must be reattached in exactly the same position as it was before it was removed.



Attaching the drive wheel

1. Ensure that all components attached to the wheel have been assembled in accordance with the manufacturer's instructions and specifications. This applies in particular to the brake and the gear shift. Then lift the rear wheel into the frame. Before you push it completely into the frame socket (dropout), insert the motor plug into the motor.
2. Place the torque receiver on the gearing.
3. Fasten the rear wheel using the stub axle / quick release skewer or axle nuts.
4. For screw axle: Tighten the axle nuts in the following order:
 1. First tighten on the gear shift side.
 2. Then tighten on the brake side.



The prescribed tightening torque of the two nuts is 35 Nm each. Also make sure that the washer is under the axle nut, otherwise there is a risk that the axle nut will come loose. If your wheels are equipped with quick release skewers or stub axles, observe the manufacturer's instructions for assembly and tightening torque. Finally, reattach all cables and supply lines to the bicycle frame with cable ties and carry out a final functional test.



Safety precautions

Before inserting the motor plug into the motor, check both the plug and socket for moisture.

Make sure that the cables are routed correctly. Incorrect routing may lead to the cable getting caught in the brake disc, the drive or the spokes, which could cause the wheel to block and result in a fall.

During all assembly work, always observe the instructions and specifications of the manufacturers of the various components attached to the wheel. This applies in particular to the brake, the gear shift, the stub axle and the quick release skewer.

Never mount the motor without the torque receiver as this would result in a total loss (cable twisted off). In this case, all warranty and guarantee claims will lapse.

In addition to your repair tool, carry 5 cable ties with you so that any cables that come loose during a journey can be securely reattached.

Always use the cassette originally installed by the bicycle manufacturer. Using other makes can result in impaired function or the cassette touching the rear end.

7.2 Recuperation

In recuperation mode, the motor acts as a generator. Power is generated which is used to charge the battery. At the same time a gentle braking effect is created. (Activating recuperation → see page 41).

The 2 recuperation stages can only be activated if the following points apply:

- Recuperation can only be activated in the speed range from 10 to 45 km/h. Recuperation cannot be activated below 10 km/h and at standstill.

- The battery cell temperature must be more than 0°C. Below 0°C, recuperation is automatically deactivated.
- The battery state of charge is less than 90%. Please note that the braking power due to recuperation depends on the battery state of charge. The lower the battery state of charge, the stronger the recuperation.

Note: Pedal assistance only lasts as long as you pedal. If you stop pedalling, the motor will stop assisting you.



7.3 Thermal management

A combination of 3 temperature sensors, an intelligent software control system and patented air circulation ensure optimal cooling of the motor. This results in more and longer lasting power on climbs or with high (trailer) loads.

Advantage: Protection against early overheating on long climbs or with high loads, resulting in longer support on hills, higher efficiency and lower battery consumption, since the motor is optimally cooled.

Theory: Like all drive units, gearless wheel hub motors are also optimised for an operating point consisting of speed, load and power. Our wheel hub motors are designed for operation in the speed range between 15 km/h and 25 km/h and a nominal tractive power of 250 W. In this speed and power range, they achieve the highest efficiency and range, which means that the supplied energy is optimally converted into drive energy. Whenever a motor is operated away from the optimum operating point, its efficiency decreases. As a result, the energy is no longer optimally converted and part of the supplied energy is converted into heat. This reduces the range, and the heat must be dissipated. In neodrives motors, this heat dissipation is achieved via a large contact surface of the motor interior (stator carrier) to the dropout or rear end of the bicycle frame. In addition, cooling fins inside and outside the drive housing ensure the greatest possible heat exchange with the environment. Any heat that cannot be dissipated leads to self-heating of the drive motor.

The neodrives wheel hub motors monitor both the supplied energy and the temperatures generated in the motor. This avoids damage due to overheating caused by an overload situation. However, this leads

to a reduction in the motor power available to the rider, to prevent overheating.

The higher the temperature rise in the motor, the less drive power is available and the less assistance is available. When the motor cools down, the energy supply is increased again and the drive power increases. **Important:** The motor cannot be damaged by overheating.

The regulation of the drive power as a function of the motor temperature is infinitely variable, so that assistance is always available, but the motor cannot be damaged by overheating.

Generally: In daily practice, the outside temperature, the total weight, the slopes, the condition of the ground surface, the air pressure and the speed all play a role. These factors can lead to a temperature being reached which reduces performance or assistance. However, this does not mean a fault or failure of the drive unit, the ride can be continued with less assistance. In isolated cases, a brief complete shutdown may occur.

An extreme example: A slope of 10 to 12% over 500 metres in altitude, a total weight of 120 kg, loose ground surface, a maximum assistance level, a riding speed of < 10 km/h and a cadence of 60 rpm mean operation in an unfavourable range with low efficiency, a low range and high heat generation at the same time. This can result in a reduction of the drive power.

Tip: Ideally, by selecting a smaller gear with a higher cadence, a lower assistance level and/or after a short break (in which the drive unit can cool down again), you can continue your ride.



Safety precautions

Under no circumstances must the motor be “forced-cooled” with water from outside! This can lead to damage and does not contribute significantly to cooling, as the interior of the motor is the hottest part.

8 Notes & troubleshooting

8.1 Maximum axle load



The maximum axle load of the motor is 120 kg.

8.2 Cleaning

Never use benzine, thinner, acetone or similar substances for any cleaning process. Likewise, do not use abrasive or aggressive cleaning agents. Instead, only use commercially available cleaning agents and disinfectants (isopropanol) as used in the household.

Cleaning the motor

The motor of your pedelec should be regularly cleaned of dirt, preferably with a dry brush or a damp (not wet) cloth. Do not carry out cleaning with running water, e.g. from a water hose or even a high-pressure cleaner. However, riding in the rain and on wet roads is possible without any problems. Wait until the motor has cooled down before cleaning the motor. Water penetrating the motor can destroy it. When cleaning, always make sure that neither liquids nor moisture penetrate the motor. Do not clean the motor while it is warm, e.g. immediately after a ride. Wait till it cools down. Otherwise, damage may occur. If the motor has been removed from the frame of the pedelec, the plug of the motor and the socket of the cable to the battery pack must be checked for possible contamination and water deposits and cleaned before assembling.

Cleaning the display

The display may only be cleaned with a damp cloth. Never use benzine, thinner, acetone or similar substances. Likewise, do not use abrasive or aggressive cleaning agents.

8.3 Transport

The following instructions must be observed when transporting the pedelec with a passenger car:

- Take appropriate measures to protect all components of your pedelec from moisture and dirt.
- Remove the battery and display from the bicycle before attaching the pedelec to the luggage rack of your car. This also reduces the weight that you have to lift, especially with a roof luggage rack system.
- Always transport the battery and the display inside your car.
- The display and battery should also be removed during transport inside the vehicle (e.g. in an estate) in order to avoid damage during loading and while driving.
- For carrier systems with bottom tube clamping, ensure that the battery attachment bar is not crushed/damaged when the clamping device is tightened.
- Make sure that cable ends cannot cause any damage to the pedelec or your car while driving.
- After driving, check all contacts of the pedelec for possible foreign objects or moisture. To ensure safe operation, all plug connections in particular must be free of dirt and foreign bodies and completely dry.
- Never place your pedelec on the side of the gear shift during transport, for example in the trunk of a car as this could damage it.

8.4 Safety precautions



Safety precautions

Do not permanently expose your pedelec to strong sunlight when not in use. This would result in the motor heating up and in extreme cases not being able to deliver full power. Plastic parts also age faster under intense sunlight.

If the system comes to a standstill due to increased temperatures (e.g. caused by uninterrupted driving or continuous direct sunlight), allow the motor to cool for about 10 minutes before continuing your journey.

The maximum speed (non-motor operation) of the system is 75 km/h. If they are exceeded, you endanger the electronic components, which can be damaged in the worst case.

8.5 Error symptoms and possible measures

Error	Troubleshooting measures
The system cannot be switched on (no display)	<ul style="list-style-type: none"> • Remove the battery from the holder, reinsert it and plug it in again if necessary. • Check the plugs, contact surfaces and contacts on the display and battery for contamination. Metal particles can accumulate and remain stubbornly adhered, especially in magnetic plugs. • Press the battery button so that the LEDs light up.
The battery cannot be charged	<ul style="list-style-type: none"> • Carefully check the battery charger plug and the battery socket for deposits. If it is a magnetic plug/socket, metal particles are quickly deposited. • Is the ambient temperature less than 0°C? The battery cannot be charged below 0°C. Always charge the battery at room temperature. • Refer to the charging instructions, especially the error codes, in the battery charger's user manual.
No motor assistance (display in operation, motor assistance not available)	<ul style="list-style-type: none"> • Remove the battery from the holder and reinsert it. If necessary, reconnect the plug. • Fully charge the battery once. • Turn the display down from the holder dock, wait about 1 minute, and then turn it back up again. • Check that all plugs are seated correctly and check all cables for cable breakage, e.g. due to strong bends. • Does a fault indication appear on the display? If yes, please consult your specialist dealer if necessary.
Recuperation does not work	<ul style="list-style-type: none"> • Is the battery state of charge greater than 90%? Recuperation only works when the battery state of charge is less than or equal to 90%. • Is the current speed less than 10 km/h? No recuperation takes place below 10 km/h. • Is the current speed more than 40 km/h? Above 40 km/h the recuperation power decreases. • Is the ambient temperature < 0°C? The battery cannot be charged below 0°C cell temperature, which also means that recuperation is not possible.
The motor does not deliver full power	<ul style="list-style-type: none"> • The motor may be in the high temperature range. From 80°C electronic temperature the power is successively reduced. Let the pedelec cool down for about 10 minutes (in the shade) and then resume the ride. • With decreasing battery charge, the performance and also the top speed decrease slightly. With an almost empty battery, the maximum speed can be 2-3 km/h below the level when driving with a fully charged battery.
Range appears to be too short	<p>The range depends on:</p> <ul style="list-style-type: none"> • Driving profile • Assistance mode • Tyre pressure • Riding behaviour • Fitness level • Total weight • External temperatures • Battery capacity • Selected route • Smartphone charging via display <p>If one of these factors is not optimal, the range can already be significantly lower. Example: At an outdoor temperature of 0°C, the range can be reduced by 30-40%.</p>

Error	Troubleshooting measures
Battery key lost	<p>Order a new key: We recommend that you note the key number on the sales or purchase receipt. You can use this number to reorder a replacement key if lost. Also note the manufacturer of the battery lock, as this may vary depending on the battery and bicycle manufacturer.</p> <p>TRELOCK Go to www.trelock.de on the Internet and select your language. Select the item "Your Service", then the sub-item "Key Service" and follow the instructions.</p> <p>AXA Go to www.keyservice.axasecurity.com on the Internet and follow the instructions.</p> <p>If you no longer have the key number, the only option is to remove the lock. Contact your specialist dealer for more information.</p>
Display does not respond	<p>Rotate the display off the twistlock and press the reset button with a pointed object for 2 seconds (small silver dot on the back of the display). Rotate the display back onto the neoTwistlock and switch the system on again.</p>
Message XXd in the display	<p>The end of the maintenance interval stored by your dealer has been reached. This time period is entered by your dealer when they maintain or update the bike. Before the service interval is exceeded, the display will show 17d (for 17 days) or 0d (for 0 days) until the end of the service interval, for example. Regular maintenance ensures that you will enjoy your e-bike for a long time to come.</p>



Alber GmbH
Vor dem Weißen Stein 21
72461 Albstadt / Germany
Telephone +49 7432 2006-0
Fax +49 7432 2006-299
info@alber.de
www.neodrives.de



 MADE IN GERMANY